

VON DUPRIN®

22 Series

Exit devices

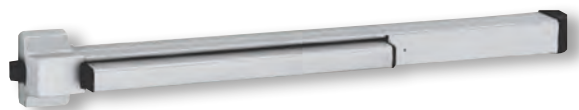

Fire Rated: Tested on fire door assemblies in accordance with Australian Standards, refer fire door manufacturer for specific approval details

The 22 Series are Von Duprin's entry level exit devices, incorporating a modern touch bar styling for all types of doors. The 22 Series can be used on timber, aluminium or hollow metal hinged doors. Available in rim and surface vertical rod styles.

The 22 Series is traditionally used in commercial buildings such as warehouses, factories, schools and shopping centres.

Features

- Non-handed
- Field sizeable to accommodate a range of door openings
- Rim device has deadlocking latch with 19mm throw
- Vertical rod device has deadlocking latches with 16mm throw
- Available in 914mm and 1220mm lengths to suit a range of door openings
- Vertical rod device suitable for doors up to 3050mm high when fitted with extension rods
- 'F' models are fire rated and have no dogging (hold open) feature
- Optional external trims available for key access
- Optional alarm kit available to deter unauthorised use of an opening
- The 10 year warranty provides specifiers and users with assured quality and performance

Specification guide

Code prefix	Model	Function	Length	Finish
VD	Rim device..... 22 Vertical rod device 2227	Regular EO Fire rated EO-F	914mm 914 1220mm 1220	Aluminium..... ALUM

- Code prefix
All codes are prefixed with VD
- Model
Select the desired model e.g. Rim device VD22
- Function
Select the desired function e.g. Fire rated VD22EO-F
- Length
Select the desired length e.g. 914mm VD22EO-F914
- Finish
Select the desired finish e.g. Aluminium VD22EO-F914ALUM

Single door VD22EO

22 Rim device

Minimum stile width 111mm with standard 299 strike

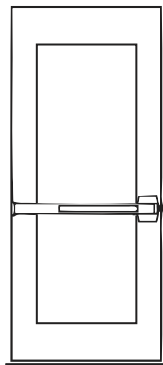

2227 Vertical rod device

Minimum stile width 92mm

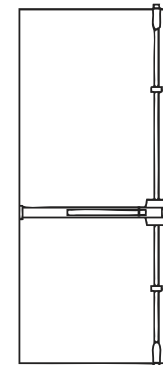

Double rebated door VDDR22

22 Rim device, 2227 Vertical rod device, 1609 Strike

Minimum stile width 111mm with optional 1609 strike

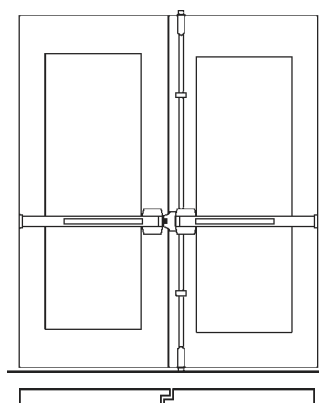

Double non-rebated door VDDD2227

2 x 2227 Vertical rod device

Minimum stile width 92mm

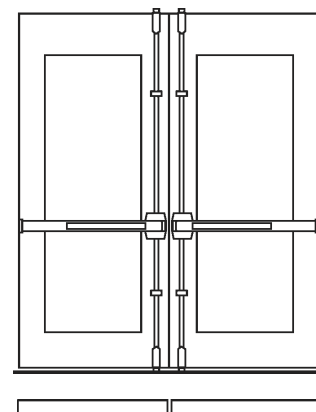

Minimum door opening chart

Device model	Door set rebate	Strike	Single door	Minimum door opening	Minimum door opening	Minimum door opening	Minimum door opening	Minimum stile width
				914 device	914 with ALK kit	1200 device	1200 with ALK kit	
22EO	13 mm	299	YES	673mm	845mm	825mm	997mm	111mm
2227EO	13 mm		YES	657mm	829mm	809mm	981mm	92mm
22EO-F	25 mm	299F	YES	698 mm	N/A	841mm	N/A	123mm
2227EO-F	25 mm		YES	645mm	N/A	797mm	N/A	104mm

Device model	Door set rebate	Strike	Double door rebated	Double door non-rebated	Minimum door opening	Minimum door opening	Minimum door opening	Minimum door opening	Minimum stile width
					914 device	914 with ALK kit	1200 device	1200 with ALK kit	
22EO & 2227EO	13mm	1609	YES		1510mm	1652mm	1818mm	1970mm	111mm
22EO-F & 2227EO-F	25mm	1609	YES		1523mm	N/A	1638mm	N/A	111mm
2227EO x 2	13mm			YES	1315mm	1658mm	1618mm	1962mm	92mm
2227EO-F x 2	25mm			YES	1340mm	N/A	1594mm	N/A	92mm

VD22EO Exit Only Rim Device

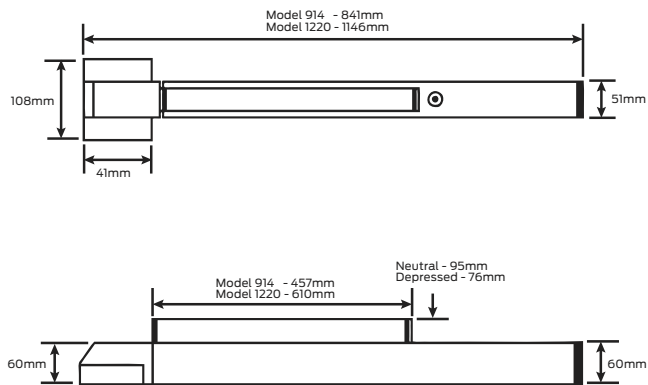

Device centre line from finished floor: 1011mm

Features

- Suitable for all types of single doors
- Can be used in conjunction with a 2227EO surface mounted vertical rod device and 1609 strike for double rebated door applications
- When 22EO is used in conjunction with 2227EO and 1609 strike on double rebated doors, the minimum stile width is 111mm
- Field sizeable to accommodate a range of door openings
- Single point locking device, with a 19mm throw deadlocking latch
- The hex key dogging allows the latch to be held in a retracted position
- A dull black 299 strike is furnished with the device
- Supplied with all fixing hardware and hex dogging key
- Optional outside trim and alarm kits are available

Specifications

Door thickness	Combination of fasteners are furnished for surface mounting or through bolting Surface mounted - 19mm minimum Through bolt - 44mm to 57mm
Stile width	121mm minimum with standard 299 strike 100mm minimum with optional 1606 strike
Door width	914mm length - 673mm minimum* 1220mm length - 825mm minimum* * based on standard strike and 13mm stop
Handing	Reversible
Latch	19mm throw, deadlocking
Dogging	Hex key dogging
Finish	Aluminium
Warranty	10 year mechanical

VD22EO-F Exit Only Fire Rated Rim Device

Features

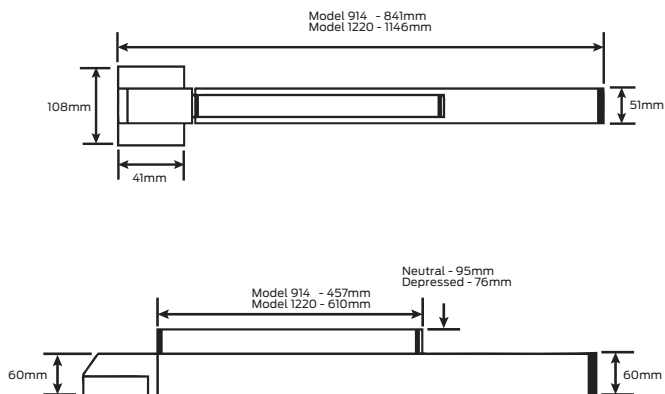

Device centre line from finished floor: 1011mm

- Suitable for all types of single doors
- Can be used in conjunction with a 2227EO-F surface mounted vertical rod device and 1609 strike for double rebated door applications
- Field sizeable to accommodate a range of door openings
- Single point locking device, with a 19mm throw deadlocking latch
- A dull black 299F strike is furnished with the device
- Device supplied with all fixing hardware
- Optional outside trim and alarm kits are available

Specifications

Door thickness	Combination of fasteners are furnished for surface mounting or through bolting Surface mounted - 19mm minimum Through bolt - 44mm to 57mm
Stile width	111mm minimum with standard 299F strike and optional 1609 strike for double rebated door applications
Door width	914mm length - 673mm minimum* 1220mm length - 825mm minimum* * based on standard strike and 13mm stop
Handing	Reversible
Latch	19mm throw, deadlocking
Finish	Aluminium
Warranty	10 year mechanical

VD2227EO Exit Only Surface Mounted Vertical Rod Device

Features

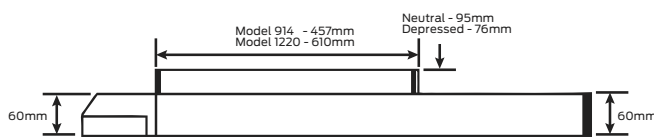
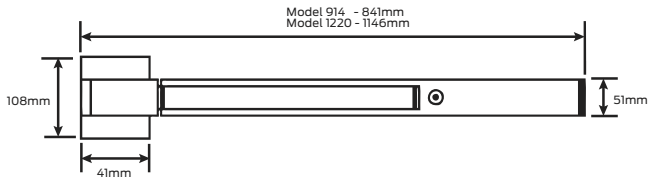

Device centre line from finished floor: 1011mm

- Suitable for all types of single doors
- Can be used in conjunction with another 2227EO for double non-rebated door applications
- For rebated double door applications the 2227EO should be used in conjunction with a 22EO rim device and 1609 strike
- Fits door stiles as narrow as 92mm
- When 2227EO is used in conjunction with 22EO and 1609 strike on double rebated doors, the minimum stile width is 111mm
- Field sizeable to accommodate a range of door openings
- Optional extension rods available for door over 2134mm high
- Multi-point locking device, with 16mm throw deadlocking anti-friction top and bottom latch
- The hex key dogging allows the latch to be held in a retracted position
- Supplied with 248L-4, 299 and 304L strikes as standard
- Optional outside trim and alarm kits are available

Specifications

Door thickness	Combination of fasteners are furnished for surface mounting or through bolting Surface mounted - 19mm minimum Through bolt - 44mm to 57mm
Stile width	92mm minimum
Door width	914mm length - 657mm minimum* 1220mm length - 825mm minimum* * based on standard strike and 13mm stop
Door height	2134mm standard. Extension rods available for door heights up to 3050mm
Handing	Reversible
Latch	16mm throw, deadlocking
Dogging	Hex key dogging
Finish	Aluminium
Warranty	10 year mechanical

VD2227EO-F Exit Only Fire Rated Surface Mounted Vertical Rod Device

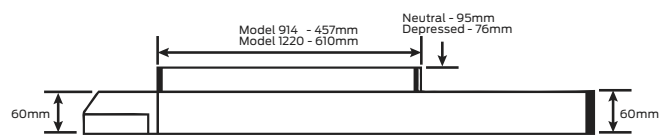
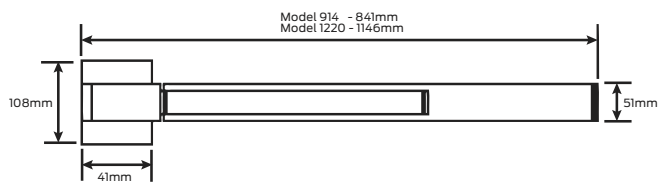

Device centre line from finished floor: 1011mm

Features

- Fire rated
- Suitable for all types of single doors
- Can be used in conjunction with another 2227EO-F for double non-rebated door applications
- For rebated double door applications the 2227EO-F should be used in conjunction with a 22EO-F rim device and 1609 strike
- Fits door stiles as narrow as 92mm
- When 2227EO-F is used in conjunction with 22EO-F and 1609 strike on double rebated doors, the minimum stile width is 111mm
- Field sizeable to accommodate a range of door openings
- Optional extension rods available for doors over 2134mm high
- Multi-point locking device, with 16mm throw deadlocking anti-friction top and bottom latch
- Supplied with 299F and 304L strikes as standard
- Optional outside trim and alarm kits are available

Specifications

Door thickness	Combination of fasteners are furnished for surface mounting or through bolting Surface mounted - 19mm minimum Through bolt - 44mm to 57mm
Stile width	92mm minimum
Door width	914mm length - 657mm minimum* 1220mm length - 825mm minimum* * based on standard strike and 13mm stop
Door height	2134mm standard. Extension rods available for door heights up to 3050mm
Handing	Reversible
Latch	16mm throw, deadlocking
Finish	Aluminium
Warranty	10 year mechanical

Suitable strikes for VD22EO

1609

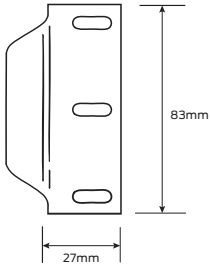

299

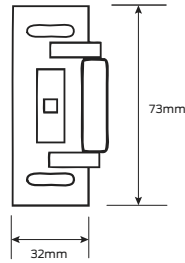

1606

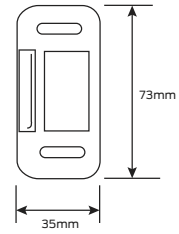

Suitable strikes for VD22EO-F

1609

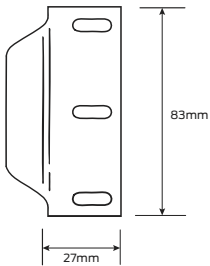

299F

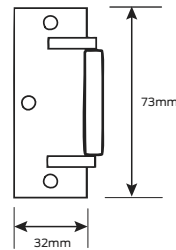

Suitable strikes for VD2227EO

248L-4

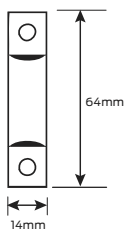

299

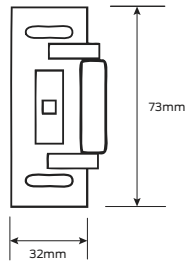

304L

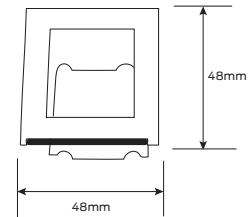

Suitable strikes for VD2227EO-F

299F

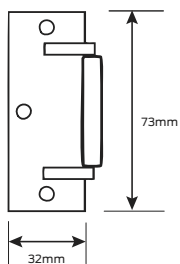

304L

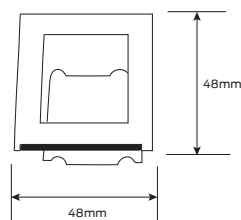

22 Series accessories

Knob VD210K

Key locks and unlocks knob. Schlage C6 key in knob cylinder supplied with trim. Trim projection is 75mm
Finish: Aluminium

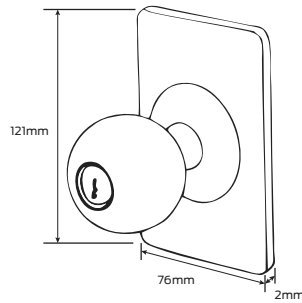

Lever VD230L

Key locks and unlocks lever. 32mm mortice cylinder ordered separately. Trim projection is 67mm
Finish: Aluminium

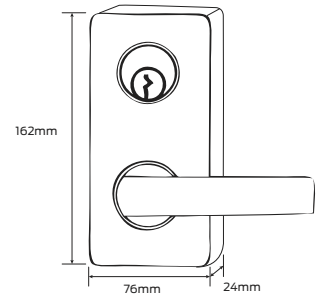

Nightlatch VD210NL

Key retracts the latch. Nightlatch cylinder ordered separately. Trim projection is 42mm
Finish: Aluminium

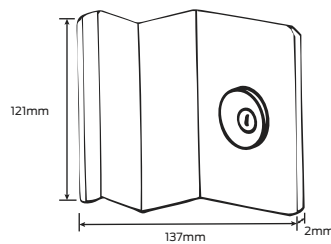

Thumbpiece VD230TP

Key locks and unlocks thumbpiece. 32mm mortice cylinder ordered separately. Trim projection is 51mm
Finish: Aluminium

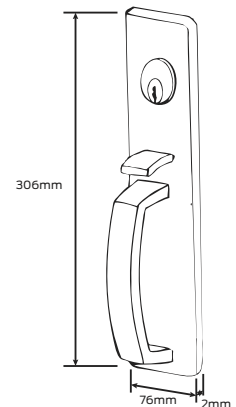

Vertical extension rods

For doors over 2134mm high. Available in either 305mm or 914mm lengths. Field sizeable
Finish: Aluminium



Hex dogging key

Dogging key supplied standard with all exit device with dogging feature

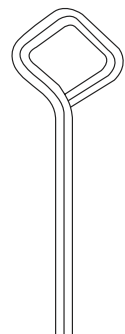

22 Series accessories

22ALK Exit alarm kit

The 22ALK exit alarm kit is a simple yet effective way to monitor the use of an exit device and deter unauthorised use of an opening. While still a means of egress, the unit contains an internal horn. When the touch bar is depressed, the horn sounds to provide an audible means of signalling that the opening has been activated. The key switch allows you to arm and disarm the alarm. The unit operates on one standard 9-volt battery. When the battery is weak, the horn will emit an intermittent signal. An "EMERGENCY EXIT ONLY. ALARM WILL SOUND" decal for application on the door is supplied as standard and requires use a 32mm mortice cylinder which is ordered separately.

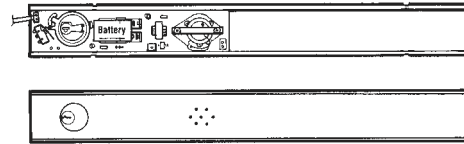

Minimum door width with alarm kit*

	914mm	1220mm
22EO	845mm	997mm
2227EO	829mm	981mm

* based on standard strike and 13mm stop height